

Алматы (7273)495-231	Калининград (4012)72-03-81	Омск (3812)21-46-40	Сыктывкар (8212)25-95-17
Ангарск (3955)60-70-56	Калуга (4842)92-23-67	Орел (4862)44-53-42	Тамбов (4752)50-40-97
Архангельск (8182)63-90-72	Кемерово (3842)65-04-62	Оренбург (3532)37-68-04	Тверь (4822)63-31-35
Астрахань (8512)99-46-04	Киров (8332)68-02-04	Пенза (8412)22-31-16	Тольятти (8482)63-91-07
Барнаул (3852)73-04-60	Коломна (4966)23-41-49	Петрозаводск (8142)55-98-37	Томск (3822)98-41-53
Белгород (4722)40-23-64	Кострома (4942)77-07-48	Псков (8112)59-10-37	Тула (4872)33-79-87
Благовещенск (4162)22-76-07	Краснодар (861)203-40-90	Пермь (342)205-81-47	Тюмень (3452)66-21-18
Брянск (4832)59-03-52	Красноярск (391)204-63-61	Ростов-на-Дону (863)308-18-15	Ульяновск (8422)24-23-59
Владивосток (423)249-28-31	Курск (4712)77-13-04	Рязань (4912)46-61-64	Улан-Удэ (3012)59-97-51
Владикавказ (8672)28-90-48	Курган (3522)50-90-47	Самара (846)206-03-16	Уфа (347)229-48-12
Владимир (4922)49-43-18	Липецк (4742)52-20-81	Саранск (8342)22-96-24	Хабаровск (4212)92-98-04
Волгоград (844)278-03-48	Магнитогорск (3519)55-03-13	Санкт-Петербург (812)309-46-40	Чебоксары (8352)28-53-07
Вологда (8172)26-41-59	Москва (495)268-04-70	Саратов (845)249-38-78	Челябинск (351)202-03-61
Воронеж (473)204-51-73	Мурманск (8152)59-64-93	Севастополь (8692)22-31-93	Череповец (8202)49-02-64
Екатеринбург (343)384-55-89	Набережные Челны (8552)20-53-41	Симферополь (3652)67-13-56	Чита (3022)38-34-83
Иваново (4932)77-34-06	Нижний Новгород (831)429-08-12	Смоленск (4812)29-41-54	Якутск (4112)23-90-97
Ижевск (3412)26-03-58	Новокузнецк (3843)20-46-81	Сочи (862)225-72-31	Ярославль (4852)69-52-93
Иркутск (395)279-98-46	Ноябрьск (3496)41-32-12	Ставрополь (8652)20-65-13	
Казань (843)206-01-48	Новосибирск (383)227-86-73	Сургут (3462)77-98-35	
	Киргизия (996)312-96-26-47	Россия (495)268-04-70	Казахстан (772)734-952-31

Precise non-contact temperature measurement of metal from 50 °C to 1800 °C

Features:

- Miniaturized Infrared Thermometer with 2.3 μm wave length range for measurements of metals, of secondary metal processing, metal oxides and ceramic materials
- Very small sensing head of 14 mm diameter and 28 mm length fits everywhere and is usable up to 85 °C ambient temperature without cooling
- Temperature measuring ranges from 50 °C to 1800 °C and exposure times starting from 1 ms
- Short wave length range of 2.3 μm to reduce error of reasuring with measurements on materials with unknown emissivity



Measurement Specifications

Temperature ranges (scalable via programming keys or software) ¹⁾	50 °C ... 400 °C (3ML) 100 °C ... 600 °C (3MH) 150 °C ... 1000 °C (3MH1) ⁴⁾ 200 °C ... 1500 °C (3MH2) ⁴⁾ 250 °C ... 1800 °C (3MH3) ⁴⁾
Spectral ranges	2.3 μm
Optical resolution (90 % energy)	22:1 (3ML) 33:1 (3MH) 75:1 (3MH1 – 3MH3)
System accuracy ²⁾ (at ambient temp. 23 ± 5 °C)	±(0.3 % of reading + 2 °C)
Repeatability (at ambient temp. 23 ± 5 °C)	±(0.1 % of reading + 1 °C)
Temperature resolution	0.1 K
Exposure time ³⁾	1 ms (90 %)
Emissivity / Gain (adjustable via programming keys or software)	0.100 – 1.100
Transmissivity / Gain (adjustable via programming keys or software)	0.100 – 1.100
Signal processing (parameter adjustable via programming keys or software, respectively)	Peak hold, valley hold, average; extended hold function with threshold and hysteresis
Software	optris® Compact Connect

¹⁾ $T_{object} > T_{sensing\ head} + 25 °C$

²⁾ $\epsilon = 1$, response time 1 s

³⁾ With dynamic adaptation at low signal levels

⁴⁾ Specification valid at $T_{object} \geq \text{start of measurement range} + 50 °C$

General Specifications

Environmental rating	IP 65 (NEMA-4)
Ambient temperature	-20 °C ... 85 °C (sensing head) 0 °C ... 85 °C (electronics)
Storage temperature	-40 °C ... 125 °C (sensing head) -40 °C ... 85 °C (electronics)
Relative humidity	10 – 95 %, non-condensing
Vibration (sensor)	IEC 68-2-6: 3 G, 11 – 200 Hz, any axis
Shock (sensor)	IEC 68-2-27: 50 G, 11 ms, any axis
Weight	40 g (sensing head) 420 g (electronics)

Electrical Specifications

Outputs / analog	0/4 – 20 mA, 0 – 5/10 V, thermocouple J, K, alarm
Outputs / alarm	24 V / 50 mA (open collector)
Optional	Relay: 2 x 60 V DC / 42 V AC _{eff} , 0.4 A; optically isolated
Outputs / digital	USB, RS232, RS485, CAN, Profibus DP, Ethernet (optional)
Output impedances	mA max. 500 Ω (with 8 – 36 V DC) mV min. 100 kΩ load impedance thermocouple 20 Ω
Inputs	Programmable functional inputs for external emissivity adjustment, ambient temperature compensation, trigger (reset of hold functions)
Cable length	3 m
Power Supply	8 – 36 V DC
Current draw	Max. 100 mA

Optical Specifications

Optics CT 3ML SF, D:S = 22:1

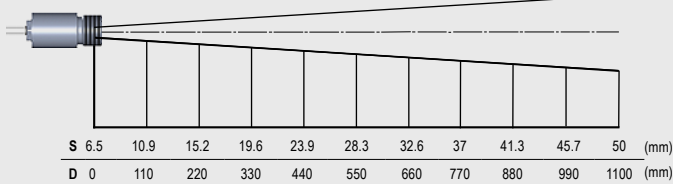

Optics CT 3ML CF, D:S = 22:1 (far field = 9:1)

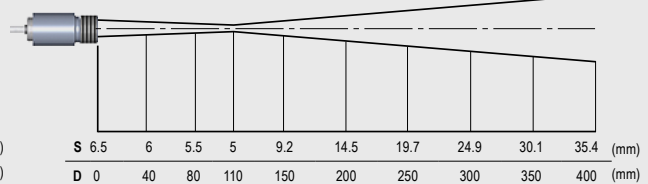

Optics CT 3MH SF, D:S = 33:1

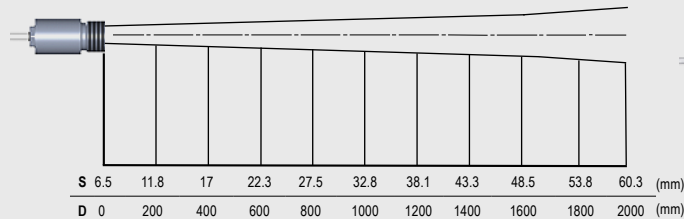

Optics CT 3MH CF, D:S = 33:1 (far field 11:1)

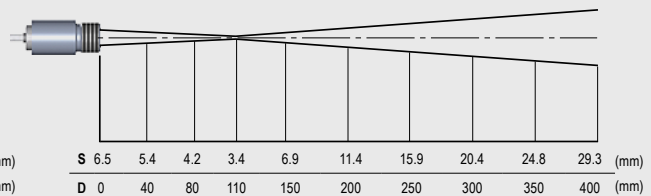

Optics CT 3MH1-H4 SF, D:S = 75:1

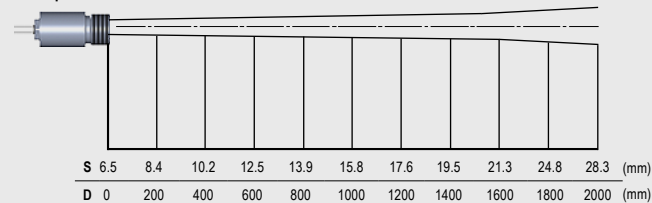

Optics CT 3MH1-H4 CF, D:S = 75:1 (far field 40:1)

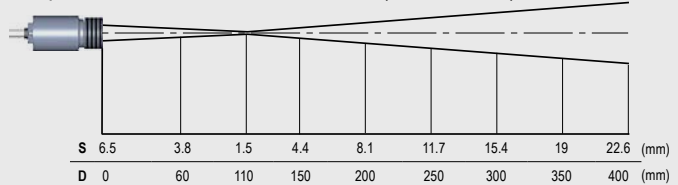

Dimensions

Sensing head

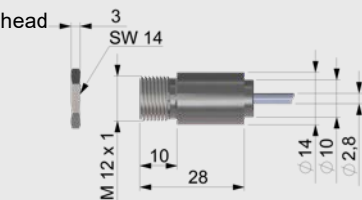

Messkopf
(built-in
CF lens)

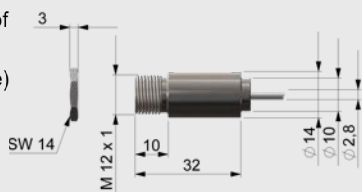

Electronics

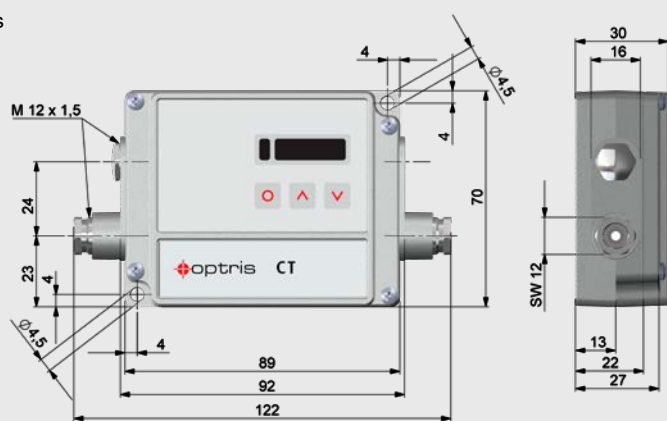

Accessories (examples)

CF-Vorsatzlinse
(ACCTCF)

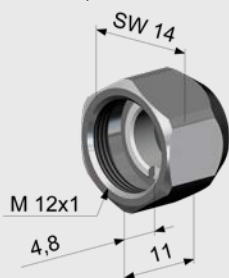

Montagewinkel, fest
(ACCTFB)

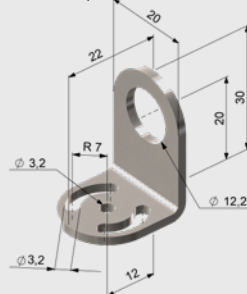

Freiblasvorsatz mit integrierter
CF-Vorsatzlinse (ACCTAPLCF)

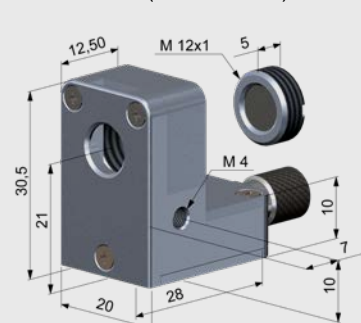

Алматы (7273)495-231
Ангарск (3955)60-70-56
Архангельск (8182)63-90-72
Астрахань (8512)99-46-04
Барнаул (3852)73-04-60
Белгород (4722)40-23-64
Благовещенск (4162)22-76-07
Брянск (4832)59-03-52
Владивосток (423)249-28-31
Владикавказ (8672)28-90-48
Владимир (4922)49-43-18
Волгоград (844)278-03-48
Вологда (8172)26-41-59
Воронеж (473)204-51-73
Екатеринбург (343)384-55-89
Иваново (4932)77-34-06
Ижевск (3412)26-03-58
Иркутск (395)279-98-46
Казань (843)206-01-48

Калининград (4012)72-03-81
Калуга (4842)92-23-67
Кемерово (3842)65-04-62
Киров (8332)68-02-04
Коломна (4966)23-41-49
Кострома (4942)77-07-48
Краснодар (861)203-40-90
Красноярск (391)204-63-61
Курск (4712)77-13-04
Курган (3522)50-90-47
Липецк (4742)52-20-81
Магнитогорск (3519)55-03-13
Москва (495)268-04-70
Мурманск (8152)59-64-93
Набережные Челны (8552)20-53-41
Нижегород (831)429-08-12
Новокузнецк (3843)20-46-81
Ноябрьск (3496)41-32-12
Новосибирск (383)227-86-73
Киргизия (996)312-96-26-47

Омск (3812)21-46-40
Орел (4862)44-53-42
Оренбург (3532)37-68-04
Пенза (8412)22-31-16
Петрозаводск (8142)55-98-37
Псков (8112)59-10-37
Пермь (342)205-81-47
Ростов-на-Дону (863)308-18-15
Рязань (4912)46-61-64
Самара (846)206-03-16
Саранск (8342)22-96-24
Санкт-Петербург (812)309-46-40
Саратов (845)249-38-78
Севастополь (8692)22-31-93
Симферополь (3652)67-13-56
Смоленск (4812)29-41-54
Сочи (862)225-72-31
Ставрополь (8652)20-65-13
Сургут (3462)77-98-35
Россия (495)268-04-70

Сыктывкар (8212)25-95-17
Тамбов (4752)50-40-97
Тверь (4822)63-31-35
Тольятти (8482)63-91-07
Томск (3822)98-41-53
Тула (4872)33-79-87
Тюмень (3452)66-21-18
Ульяновск (8422)24-23-59
Улан-Удэ (3012)59-97-51
Уфа (347)229-48-12
Хабаровск (4212)92-98-04
Чебоксары (8352)28-53-07
Челябинск (351)202-03-61
Череповец (8202)49-02-64
Чита (3022)38-34-83
Якутск (4112)23-90-97
Ярославль (4852)69-52-93
Казахстан (772)734-952-31