

Алматы (7273)495-231
 Ангарск (3955)60-70-56
 Архангельск (8182)63-90-72
 Астрахань (8512)99-46-04
 Барнаул (3852)73-04-60
 Белгород (4722)40-23-64
 Благовещенск (4162)22-76-07
 Брянск (4832)59-03-52
 Владивосток (423)249-28-31
 Владикавказ (8672)28-90-48
 Владимир (4922)49-43-18
 Волгоград (844)278-03-48
 Вологда (8172)26-41-59
 Воронеж (473)204-51-73
 Екатеринбург (343)384-55-89
 Иваново (4932)77-34-06
 Ижевск (3412)26-03-58
 Иркутск (395)279-98-46
 Казань (843)206-01-48

Калининград (4012)72-03-81
 Калуга (4842)92-23-67
 Кемерово (3842)65-04-62
 Киров (8332)68-02-04
 Коломна (4966)23-41-49
 Кострома (4942)77-07-48
 Краснодар (861)203-40-90
 Красноярск (391)204-63-61
 Курск (4712)77-13-04
 Курган (3522)50-90-47
 Липецк (4742)52-20-81
 Магнитогорск (3519)55-03-13
 Москва (495)268-04-70
 Мурманск (8152)59-64-93
 Набережные Челны (8552)20-53-41
 Нижний Новгород (831)429-08-12
 Новокузнецк (3843)20-46-81
 Ноябрьск (3496)41-32-12
 Новосибирск (383)227-86-73
 Киргизия (996)312-96-26-47

Омск (3812)21-46-40
 Орел (4862)44-53-42
 Оренбург (3532)37-68-04
 Пенза (8412)22-31-16
 Петрозаводск (8142)55-98-37
 Псков (8112)59-10-37
 Пермь (342)205-81-47
 Ростов-на-Дону (863)308-18-15
 Рязань (4912)46-61-64
 Самара (846)206-03-16
 Саранск (8342)22-96-24
 Санкт-Петербург (812)309-46-40
 Саратов (845)249-38-78
 Севастополь (8692)22-31-93
 Симферополь (3652)67-13-56
 Смоленск (4812)29-41-54
 Сочи (862)225-72-31
 Ставрополь (8652)20-65-13
 Сургут (3462)77-98-35
 Россия (495)268-04-70

Сыктывкар (8212)25-95-17
 Тамбов (4752)50-40-97
 Тверь (4822)63-31-35
 Тольятти (8482)63-91-07
 Томск (3822)98-41-53
 Тула (4872)33-79-87
 Тюмень (3452)66-21-18
 Ульяновск (8422)24-23-59
 Улан-Удэ (3012)59-97-51
 Уфа (347)229-48-12
 Хабаровск (4212)92-98-04
 Чебоксары (8352)28-53-07
 Челябинск (351)202-03-61
 Череповец (8202)49-02-64
 Чита (3022)38-34-83
 Якутск (4112)23-90-97
 Ярославль (4852)69-52-93
 Казахстан (772)734-952-31

Precise non-contact temperature measurement from 250 °C to 2200 °C

Features:

- Miniaturized Infrared Thermometer with 1.0 μm respectively 1.6 μm wave length range for measurements of metals, of secondary metal processing, metal oxides and ceramic materials
- Very small sensing head of 14 mm diameter and 28 mm length fits everywhere and is usable up to 125 °C ambient temperature without cooling
- Temperature ranges from 250 °C to 2200 °C, measuring spots up from 1.8 mm and exposure times up from 1 ms
- Short measuring wave length of 1.0 μm respectively 1.6 μm reduces error of temperature readings on surfaces with low or unknown emissivity



General Specifications

Environmental rating	IP 65 (NEMA-4)
Ambient temperature	-20 °C ... 100 °C (1M) to 125 °C (2M) (sensing head) 0 °C ... 85 °C (electronics)
Storage temperature	Sensing head: -40 °C ... 100 °C (1M) to 125 °C (2M) Electronics: -40 °C ... 85 °C
Relative humidity	10–95 %, non condensing
Vibration (sensor)	IEC 68-2-6: 3 G, 11–200 Hz, any axis
Shock (sensor)	IEC 68-2-27: 50 G, 11 ms, any axis
Weight	Sensing head: 40 g / Electronics: 420 g

Electrical Specifications

Outputs / analog	0/4 – 20 mA, 0–5/10 V, thermocouple J, K, alarm output
Output / alarm	24 V / 50 mA (open collector)
Optional	Relay: 2 x 60 V DC / 42 V AC _{eff} ; 0.4 A; optically isolated
Outputs / digital	USB, RS232, RS485, CAN, Profibus DP, Ethernet (optional)
Output impedances	mA max. 500 Ω (with 8–36 V DC) mV min. 100 kΩ load impedance thermocouple 20 Ω
Inputs	Programmable functional inputs for external emissivity adjustment, ambient temperature compensation, trigger (reset of hold functions)
Cable length	3 m (standard), 8 m, 15 m
Power Supply	8–36 V DC
Current draw	Max. 100 mA

Measurement Specifications

Temperature ranges (scalable via programming keys or software)	485 °C ... 1050 °C (1ML) 650 °C ... 1800 °C (1MH) 800 °C ... 2200 °C (1MH1) 250 °C ... 800 °C (2ML) 385 °C ... 1600 °C (2MH) 490 °C ... 2000 °C (2MH1)
Spectral ranges	1.0 μm (1M) / 1.6 μm (2M)
Optical resolution CT 1ML / 2ML (90 % energy)	40:1 (2.7 mm @ 110 mm)
Optical resolution CT 1MH / 1MH1 / 2MH / 2MH1 (90 % energy)	75:1 (1.5 mm @ 110 mm)
System accuracy ¹⁾ (at ambient temp. 23 ± 5 °C)	±(0.3 % of reading + 2 °C)
Repeatability (at ambient temp. 23 ± 5 °C)	±(0.1 % of reading + 1 °C)
Temperature resolution	0.1 K
Exposure time ²⁾	1 ms (90 %)
Emissivity / Gain (adjustable via programming keys or software)	0.100 – 1.100
Transmissivity / Gain (adjustable via programming keys or software)	0.100 – 1.100
Signal processing (parameter adjustable via programming keys or software, respectively)	Peak hold, valley hold, average; extended hold function with threshold and hysteresis
Software	optris® Compact Connect

¹⁾ ε = 1, Exposure time 1 s

²⁾ With dynamic adaptation at low signal levels

Optical Specifications

CT 1ML/2ML SF, D:S = 40:1

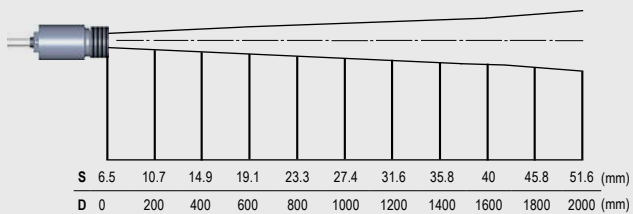

CT 1ML/2ML CF, D:S = 40:1 (Fernfeld = 12:1)

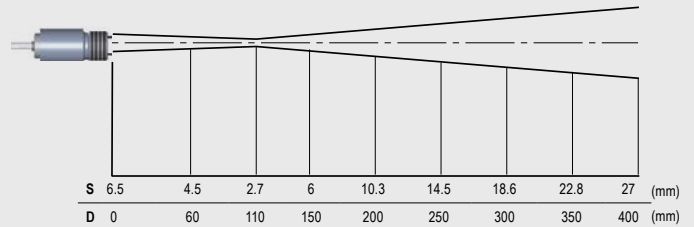

CT 1MH/1MH1/2MH/2MH1 SF, D:S = 75:1

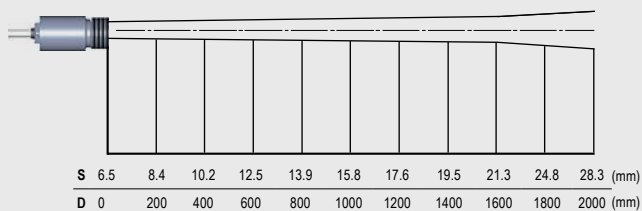

CT 1MH/1MH1/2MH/2MH1 CF, D:S = 75:1 (far field = 14:1)

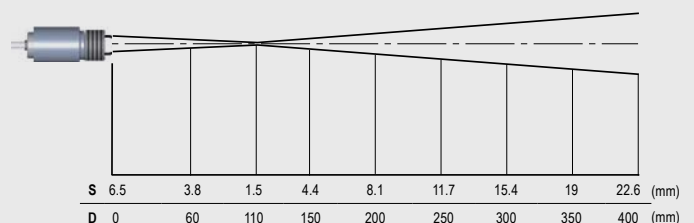

Dimensions

Sensing head

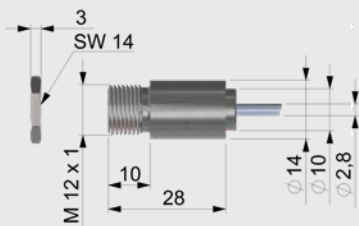

Electronics

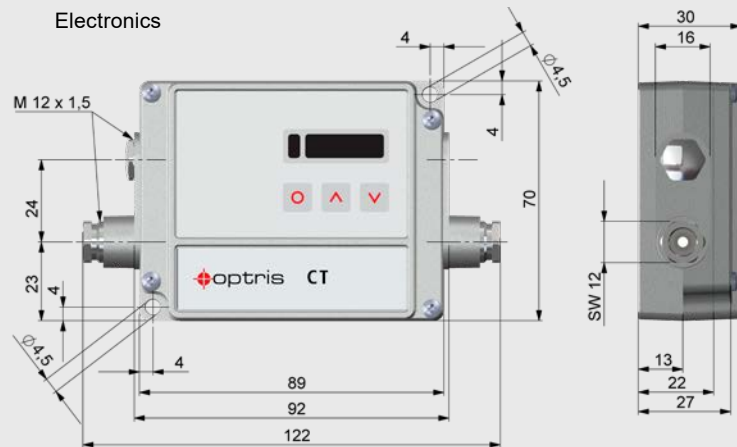

Accessories (examples)

CF-lens (ACCTCFHT)

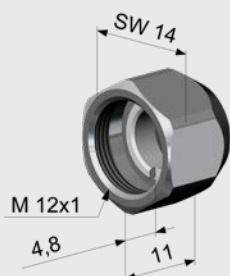

Air purge collar with integrated CF-lens (ACCTAPLCFHT)

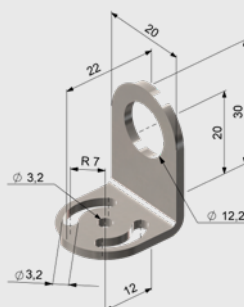

Mounting bracket, fixed (ACCTFB)

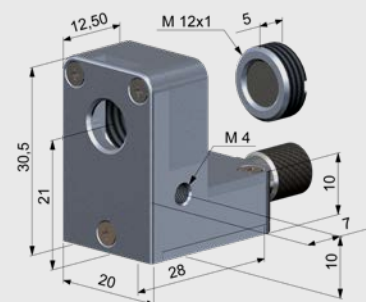

Алматы (7273)495-231
Ангарск (3955)60-70-56
Архангельск (8182)63-90-72
Астрахань (8512)99-46-04
Барнаул (3852)73-04-60
Белгород (4722)40-23-64
Благовещенск (4162)22-76-07
Брянск (4832)59-03-52
Владивосток (423)249-28-31
Владикавказ (8672)28-90-48
Владимир (4922)49-43-18
Волгоград (844)278-03-48
Вологда (8172)26-41-59
Воронеж (473)204-51-73
Екатеринбург (343)384-55-89
Иваново (4932)77-34-06
Ижевск (3412)26-03-58
Иркутск (395)279-98-46
Казань (843)206-01-48

Калининград (4012)72-03-81
Калуга (4842)92-23-67
Кемерово (3842)65-04-62
Киров (8332)68-02-04
Коломна (4966)23-41-49
Кострома (4942)77-07-48
Краснодар (861)203-40-90
Красноярск (391)204-63-61
Курск (4712)77-13-04
Курган (3522)50-90-47
Липецк (4742)52-20-81
Магнитогорск (3519)55-03-13
Москва (495)268-04-70
Мурманск (8152)59-64-93
Набережные Челны (8552)20-53-41
Нижний Новгород (831)429-08-12
Новокузнецк (3843)20-46-81
Ноябрьск (3496)41-32-12
Новосибирск (383)227-86-73
Киргизия (996)312-96-26-47

Омск (3812)21-46-40
Орел (4862)44-53-42
Оренбург (3532)37-68-04
Пенза (8412)22-31-16
Петрозаводск (8142)55-98-37
Псков (8112)59-10-37
Пермь (342)205-81-47
Ростов-на-Дону (863)308-18-15
Рязань (4912)46-61-64
Самара (846)206-03-16
Саранск (8342)22-96-24
Санкт-Петербург (812)309-46-40
Саратов (845)249-38-78
Севастополь (8692)22-31-93
Симферополь (3652)67-13-56
Смоленск (4812)29-41-54
Сочи (862)225-72-31
Ставрополь (8652)20-65-13
Сургут (3462)77-98-35
Россия (495)268-04-70

Сыктывкар (8212)25-95-17
Тамбов (4752)50-40-97
Тверь (4822)63-31-35
Тольятти (8482)63-91-07
Томск (3822)98-41-53
Тула (4872)33-79-87
Тюмень (3452)66-21-18
Ульяновск (8422)24-23-59
Улан-Удэ (3012)59-97-51
Уфа (347)229-48-12
Хабаровск (4212)92-98-04
Чебоксары (8352)28-53-07
Челябинск (351)202-03-61
Череповец (8202)49-02-64
Чита (3022)38-34-83
Якутск (4112)23-90-97
Ярославль (4852)69-52-93
Казахстан (772)734-952-31